



USER INSTRUCTION MANUAL
EDGE FLANGE ANCHORS

THESE INSTRUCTIONS APPLY TO THE FOLLOWING MODELS:
AFA930501, AFA930502, AFA930503

EN 795:2012 TYPE A

Please read and understand the manufacturer's instructions for each component or part of the complete system. Manufacturer's instructions must be followed for proper use, care, and maintenance of this product. These instructions must be retained and be kept available for the user's reference at all times. Alterations or misuse of this product, or failure to follow instructions, may result in serious injury or death.

Note: The user is advised to keep this user instructions document for the life of the product.

- 1. INTRODUCTION:** These Anchors are classed as Personal Protective Equipment (PPE) by the European PPE Regulation (EU)2016/425 and have been shown to comply with this Regulation through the Harmonized European Standard EN 795 :2012 TYPE A.
These Anchors are designed to minimize the risk of /provide protection against the danger of falling from heights. However, always remember that no item of PPE can provide full protection and care must always be taken while carrying out the risk related activity.
- 2. PERFORMANCE AND LIMITATIONS OF USE:** The Anchor devices have been tested in accordance with EN 795:2012 and have achieved the following performance levels-

EN 795:2012 test	Result/Comment
General Requirements for Anchor devices (Clause 4.1)	(PASS) No sharp edges (PASS).
Static Strength (Clause 4.4.2.3)	Sustained a force of 12 kN for 3 minutes (PASS).
Dynamic Strength (Clause 4.4.2.2)	When tested with rigid steel mass of 100 kg, the test mass held after test with the device remaining stable throughout. (PASS)
Corrosion Resistance (Clause 4.2.2.1)	No corrosion evident after 48 hours of salt spray testing. (PASS)

- 3. APPLICATION:** KStrong Flange Anchors are specifically designed to be fixed on walls, ceilings, roof tops, or steel structures.
- 4. INSPECTION:** Visually inspect the system before each use to ensure that it is in a serviceable condition and is operating correctly. If during inspection, doubts are raised about the safety of the system or a component, these should be replaced either by the manufacturer or a competent person.
- 5. PRECAUTIONS:**
 - Ensure the Medical condition of the user does not affect his safety in normal and emergency use.
 - The equipment shall only be used by a person trained and competent in its safe use.
 - A rescue plan shall be in place to deal with any emergencies that could arise during the work.
 - Ensure that the anchor is installed directly above the user's head.
 - It is essential to verify free space required beneath the user at work place before each occasion of use so that in case of a fall there will be no collision with ground or other obstacle in the fall path.
- 6. INSTRUCTIONS FOR USAGE OF -AFA930501/ AFA930502 / AFA930503**

- AFA930501 / AFA930502 & AFA930503 can be used with chemical, mechanical fasteners in pre-defined hole of dia. 10mm & 12 mm respectively with a hole of 95mm.
- Insert the fastener (as shown in below shown picture) upto the length of 90mm.Refer Hilti Fastener Guide for Concrete installation.
- Insert the Flange Anchor AFA930501 / AFA930502/ AFA930503 followed by the washer and tighten the nut to the fullest.
- Now the eye of the flange anchor can / may be used as anchorage point.

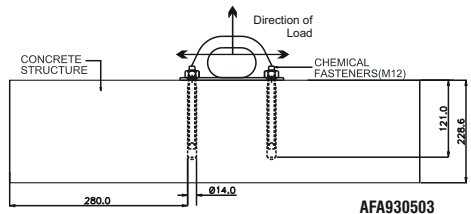
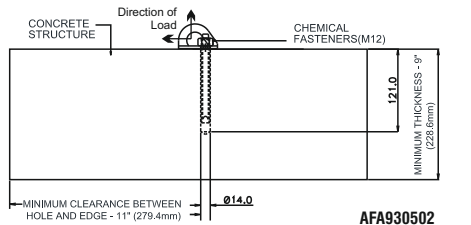
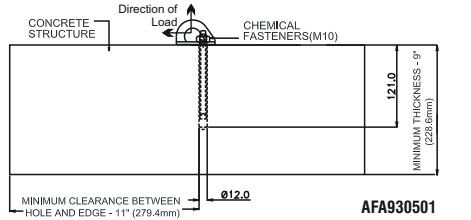

7. **ANCHORAGE POINT** : Ensure that the structure on to which the anchor is fitted is strong enough to withstand a load of 12 kN. If unsure of structure strength, refer to an engineer.

8. **LIMITATIONS** :

- It should be the personal property of its user.
- It should not be used in highly acid or basic environment.
- The anchor has been tested to EN 795:2012 and is appropriate only for single person use with an energy absorber as per EN 355:2002 that is rated to user mass up to 140 Kg.
- Ensure that the Anchor is installed directly above the user's head.
- Ensure that the equipment is compatible with other items when assembled into a system.
- It is essential to verify the free space required beneath the user at work place before each occasion of use so that in case of a fall there will be no collision with ground or other obstacle in the fall path.
- It is essential for the safety of user that if the product is resold outside the original country of destination, the reseller shall provide instruction for use, for maintenance, for periodic examination and for repair in the language of the country in which product is to be used.

9. **COMPATIBILITY**: To optimise protection, in some instance it may be necessary to use the anchorage sling with suitable PPE such as: boots/gloves/helmet and ear protection. In this case, before carrying out the risk-related activity, consult your supplier to ensure that all your protective products are compatible and suitable for your application.

10. **REPAIR**: If the product becomes damaged, it will NOT provide the optimum level of protection, and therefore should be immediately removed from service. It needs to be inspected to see if it is replaced or repaired. Never use the damaged product. Repair is only permitted by the manufacturer or a nominated repair centre or individual approved by the manufacturer.

11. **CLEANING & MAINTENANCE**: In case of minor soiling, wipe the anchor with cotton cloth or a soft brush. Do not use any abrasive material. For intensive cleaning wash the anchor in water at a temperature between 30°C to 60°C by using a neutral detergent (pH 7). The washing temperature should not exceed 60°C. Do not use acid or basic detergents.

12. **STORAGE AND TRANSPORT**: When not in use, store the anchor away from heavily acidic or basic environment. Never place heavy items on top of it. Also ensure that it is stored away from chemically hazardous environment preferably storage should be in dry environment.

13. **WITHDRAWAL FROM USE** : If the system has been used to arrest a fall, it should be removed from service and returned to the manufacturer or a competent repair centre for servicing and re test.

14. **WARNING**:

- Do not make any alterations or additions to the equipment without the manufacturer's prior written consent and that any repair shall only be carried out by personnel trained by the manufacturer & duly authorized by him.
- The equipment shall not be used outside its limitation, or for any purpose other than that for which it is intended.

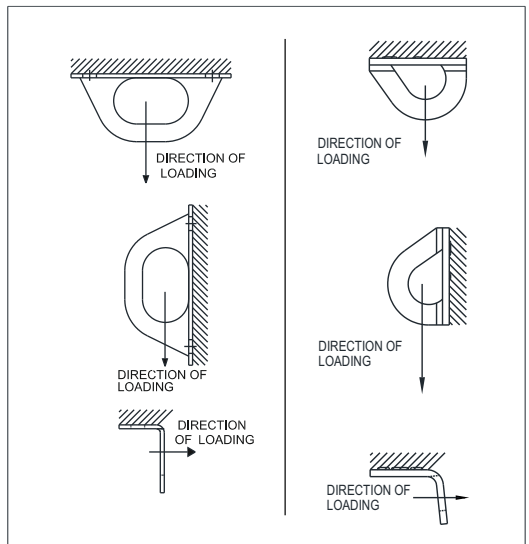
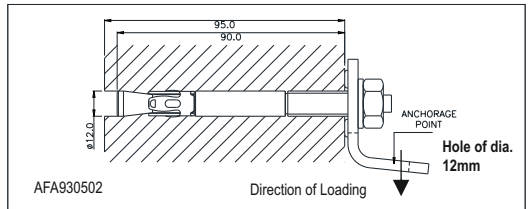
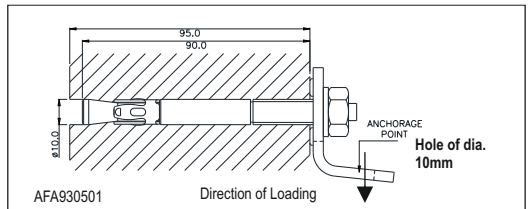
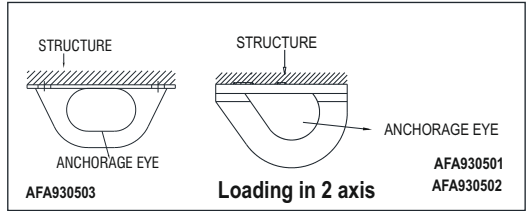

MARKING

(ii) **KSTRONG®**

(iii) Product Ref. : AFA930501 / AFA930502

(iv) Product Description : Edge Flange Anchor

(v) UID : XXXXXXXXXXXX
MFG. DT. XXXX

(vi) EN 795:2012 Type A

(i) MBS : 15kN

MAX

(vii)

Read the user instructions carefully before each use.

The Anchor is marked with :

- (i) Minimum breaking strength
- (ii) Identification of the manufacturer
- (iii) Type or product code
- (iv) Product description
- (v) UID for traceability
- (vi) Norm Reference
- (vii) For Single User

LIFESPAN: The estimated product Lifespan is 10 years from the date of manufacture. The following factors can reduce the Lifespan of the product: intense use, contact with chemical substances, specially aggressive environments, extreme temperature exposure, UV exposure, abrasions, cuts, violent impacts, bad use or maintenance.

DISCLAIMER: Prior to use, the end user must read and understand the manufacturer's instructions supplied with this product at the time of shipment and seek training from their employer's trained personnel on the proper usage of the product. Manufacturer is not liable or responsible for any loss, damage or injury caused or incurred by any person on grounds of improper usage or installation of this product.

EQUIPMENT RECORD				
Product				
Model & type/Identification		Trade Name		Identification number
Manufacturer		Address		Tel, email into use
Year of manufacture		Purchase Date		Date first put into use
Other relevant information (eg. document number)				
PERIODIC EXAMINATION AND REPAIR HISTORY				
Date	Reason for entry (periodic examination or repair)	Defects noted, repairs carried out and other relevant information	Name and signature of competent person	Periodic examination next due date

Certification Body:

SATRA Technology Centre, Wyndham Way, Telford Way, Kettering, NN16 8SD, UK (Notified Body 0321)

For EU Declaration, please visit <https://kstrong.com/asia/eu-declaration-form/>



150 N. Radnor Chester Road Suite F200
Radnor, Pennsylvania 19087 United States
Contact Email: customer care@kstrong.com

USA	South America	ASIA
-----	---------------	------