

# EXTREME PERSONAL WINCH 35M

AFT730135

KStrong Extreme Winches have been designed for lifting and lowering, ideal for a range of applications including confined space work, rescue, positioning and personnel/material handling.

## Features

- Material or man-lifting rescue winch.
- Comes with an independent reel mode for quick and easy installation of the winch.
- Equipped with a secondary brake mechanism which reduces the dynamic load impact felt on the user in the event of a fall, to less than 6 kN.
- Comes with universal mounting bracket to attach the Extreme Davits and Tripods for quick and easy installation
- Handle rotating mechanism for lifting or lowering.



## How To Use

Refer to User Instruction Manual 

## Metal Components

Body	:	Alloy Steel
Finish	:	ED Coated (Black)
Rated Load Capacity	:	As per EN 1496:140 kgs As per machine directive 2006/42/EC: 250 kgs
Wire Cable	:	6 mm Galvanized Steel
Steel Snap Hook	:	23kN MBS

## Weight

15.25kgs ± 0.10kgs

## System Strength

15kN MBS

## Relevant Standards

Tested as per EN 1496:2017 Class B & ANSI Z359.4-2013

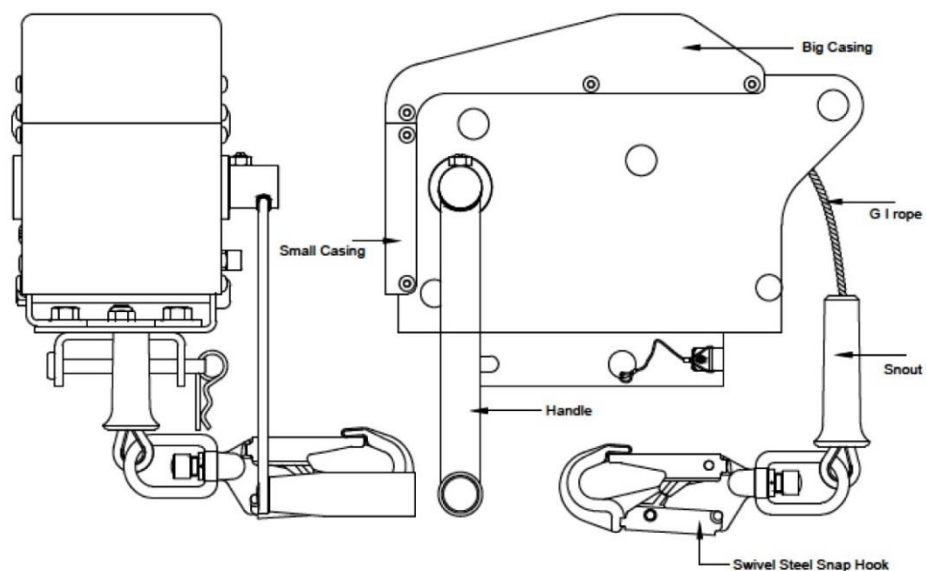

II 2G  
Ex h IIc T6 Gb  
EN 80079-36:2016  
EN 80079-37:2016